

The PUR-X series replaceable tube circulation heater provides contamination-free heating of liquids and gases.

**APPLICATIONS**

- Semiconductor solvent heating
- High-purity liquid heating

**SPECIFICATIONS**

- PUR-X 2000: 5.0kW – 7.9kW, 120V, 200V, 208V, 220V, 230V, 240V, 380V, 400V, 415V, 480V
- Explosion Resistant (NEMA 7) electrical enclosure
- Tubing, .375" (3/8") O.D. x .031" wall, field replaceable
  - Standard PFA
  - High purity PFA, compliant with SEMI F57
  - 325" Long (27ft or 8.3m)
  - Tube size & length are the same for both standard
  - PFA & high purity PFA
- Body: Aluminum 319, Teflon®-coated
- Maximum operating temperature: 200°C (392°F)
- Two sensors, for process control and process high-limit, choice of J or K type thermocouples
- Third sensor (J or K type, matching the selected process sensors) for casting and tube protection. Requires independent high limit control loop set no higher than 235° C (455° F).
- Optional insulation jacket
- Optional fittings, PFA 3/8" Straight Union, Semi F57 compliant
- 70 psi max (480 kPa)
- Size and weight:
  - PUR-X 2000: 4.3" O.D. (10.9cm) x 22" (55.9cm) tall
  - 29 lbs (13.1Kg) (includes housing)



**PUR-X 2000 without insulation jacket**



**PUR-X 2000 with insulation jacket**

**FEATURES/BENEFITS**

- Heating elements cast in aluminum
- Low maintenance
- Teflon®- coated for easy cleaning
- High purity heating
- Fluid path independent of heater sheath
- Non-welded construction
- Self-draining
- Replaceable tubing

**APPLICATIONS**

- Semiconductor wet process systems
- Wafer cleaning equipment (wet bench systems)
- Heating of photo-resist removal solvents
- DI water heating for wafer rinsing
- Air and Nitrogen heating for wafer drying
- Acid heating

**TECHNICAL DRAWING**

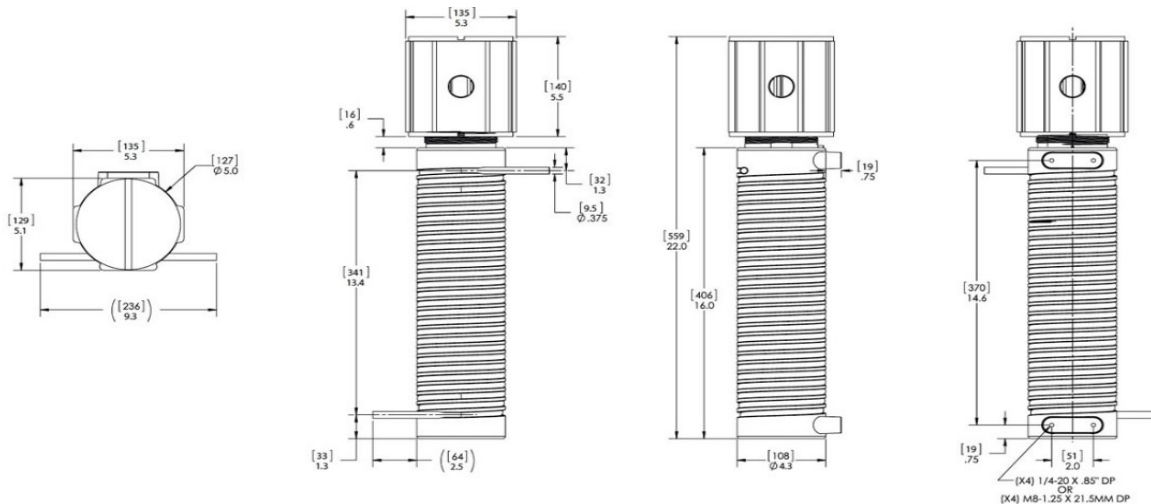

**HEATING PROFILE (WATER)**

Inlet water 15°C (59°F) at 200°C (392°F) set point with insulation jacket.

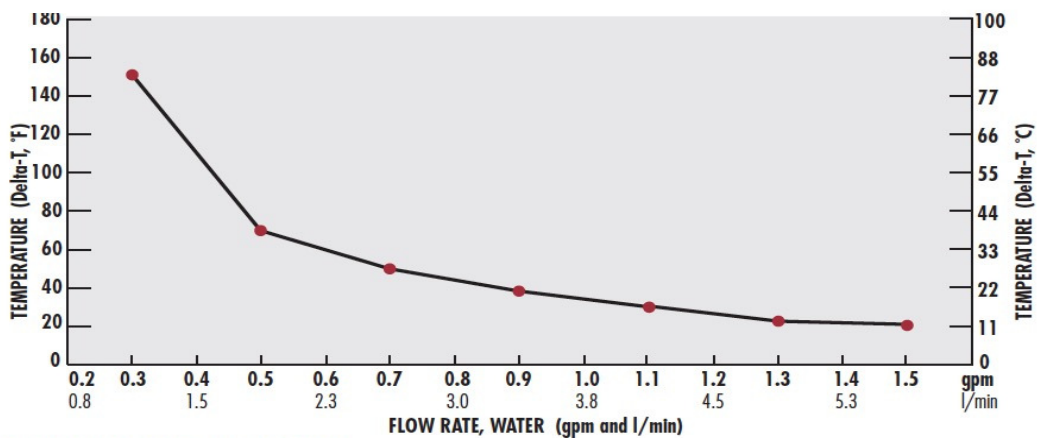

**PRESSURE DROP PROFILE (WATER)**

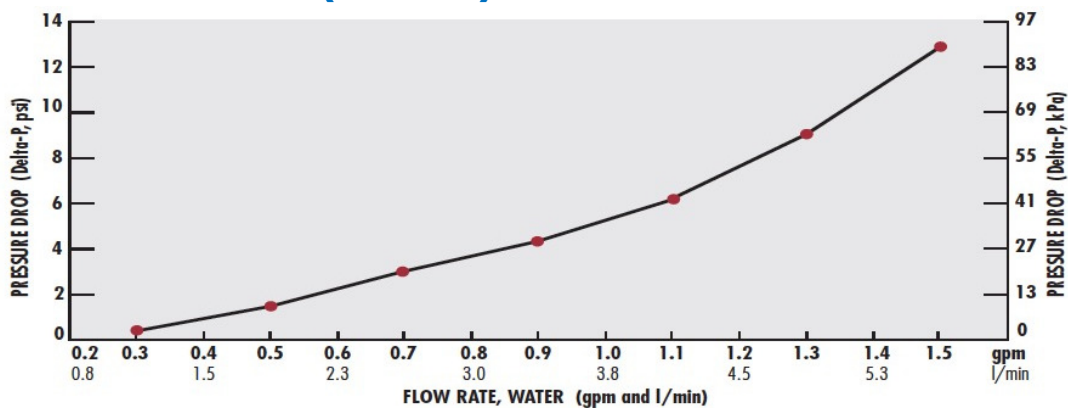

**WIRING DIAGRAMS**

**3-Phase Delta**

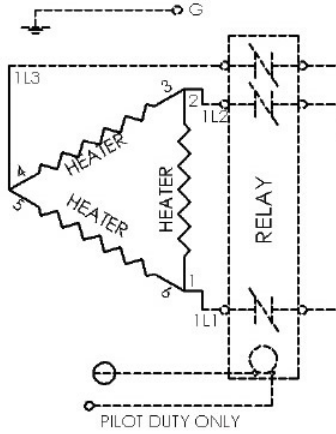

**3-Phase Wye**

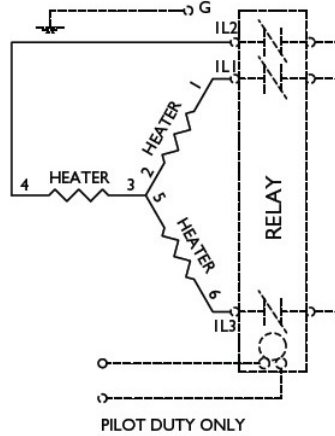

**1-Phase Circuit**

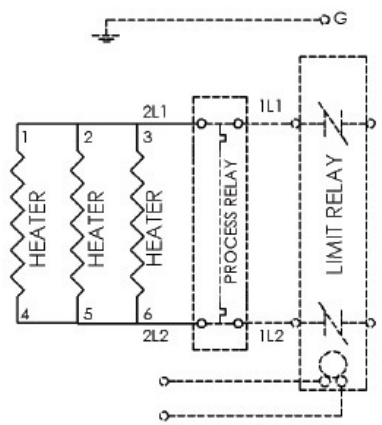

**HEATING PROFILE (AIR)**

Inlet air at 21°C (70°F) and 70psi; 200°C (392°F) set point with insulation jacket.

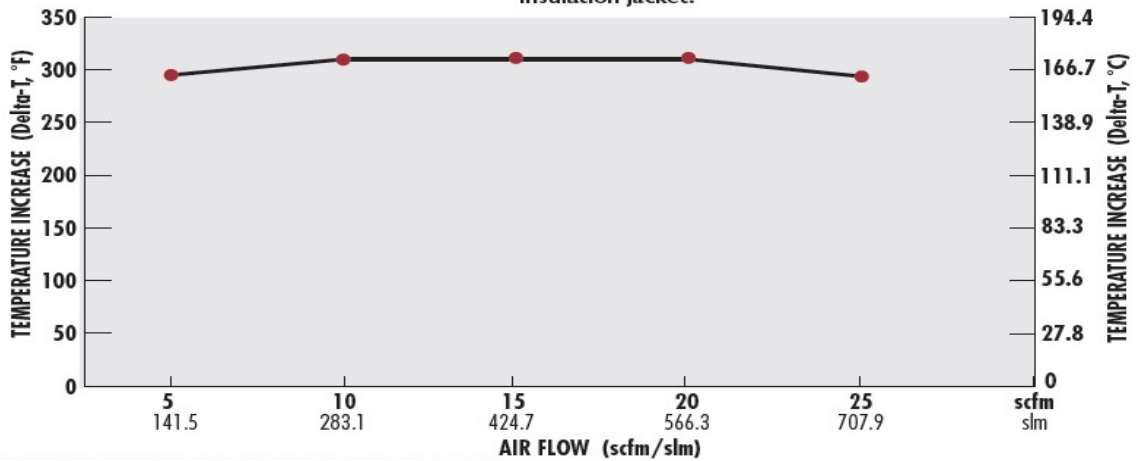

**PRESSURE DROP (AIR)**

