

RTDs and Thermistors

Resistance Temperature Sensing

RTDs

Watlow's platinum resistance elements are specially designed to ensure precise and repeatable temperature versus resistance characteristics. The sensors are made with controlled purity platinum, have high purity ceramic components and constructed in a unique strain-free manner.

Performance Capabilities

- Ceramic elements are extremely precise and stable within the wide temperature range of -200 to 650°C (-328 to 1200°F).

Features and Benefits

Patented, strain-free construction

- Provides dependable, accurate readings
- Allows elements from different lots to be substituted without recalibration

High signal-to-noise output

- Increases accuracy of data transmission
- Permits greater distances between sensor and measuring equipment

Temperature coefficient (alpha) carefully controlled while insulation resistance values exceed DIN-IEC-751 standards

- Ensures sensor sensitivity
- Minimizes self heating
- Allows precise measurement
- Repeatable

Highly controlled manufacturing process

- Ensures wide temperature range
- Stabilizes physical and chemical attributes

Metric diameters and fittings are available, please consult factory



Applications

- Air conditioning and refrigeration servicing
- Furnace servicing
- Stoves and grills
- Textile production
- Plastics processing
- Petrochemical processing
- Micro electronics
- Air, gas and liquid temperature measurement
- Exhaust gas temperature measurement

RTDs and Thermistors

RTD Style RB

Standard Industrial Insulated Leads

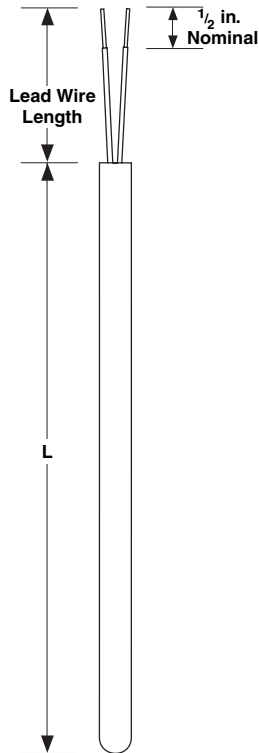

Features and Benefits

High accuracy

- Dependable readings

Customized diameters

- From 0.125 to 0.250 inch

Epoxy sealed

- Resist moisture and pull out
- Standard 260°C (500°F) potting

Durable rigid sheath

- 316 stainless steel -50 to 260°C (-58 to 500°F)

Internal heat transfer paste

- Quick time response

① Certain option combinations must be furnished with a transition between the sheath and lead wire, consult factory if transition is unacceptable.

② May require transition.

③ Requires two- or three-wire, single element only.

* One inch sheath length for 0.188 diameter requires a crimp tube within the last half inch of the tube.

Rapid Ship Sensors

Rapid Ship sensors come with 100Ω DIN 0.00385 curve, 316 stainless steel, 0.188 inch diameter, TFE three-wire, four foot leads, temperature rating -50 to 260°C (-58 to 500°F), standard split end lead termination and no mounting fittings. See page 166 to order additional connector hardware.

Class Accuracy	Sheath Length in. (mm)	Part Number 4 foot (102 mm) Leads
A	2 (51)	RBHB0TA020BA040
	4 (102)	RBHB0TA040BA040
	6 (152)	RBHB0TA060BA040
	9 (229)	RBHB0TA090BA040
	12 (305)	RBHB0TA120BA040

Custom Ordering Information—Items in **Bolded Green Type** are preferred with shorter lead times.

1 2 3 4 5 6 7 8 9 10 11 12 13 14 15

R B A

3. Sheath O.D. (inch) _____
 G = 0.125
H = 0.188
J = 0.250

4. Lead Wire Construction^① _____
 Standard Overbraided Flex Armor
 Fiberglass Stranded **A** J^② R^②
 PFA or TFE Stranded **B** L^② T^②

5. Fittings _____
 If required, enter order code from pages 39 to 40.
If none, enter "0".

6. Lead Wire Termination _____
 A^③ = Standard male plug 200°C (400°F)
 B^③ = Standard female plug
 C^③ = Standard plug with mating connector
 J^③ = Male miniature plug
 K^③ = Female miniature jack
 L^③ = Male/female mini set
T = Standard leads
 U = Leads with spade lugs

7. Sheath Construction _____
A = 316 SS

8-9. Sheath Length "L" (inch) _____
02, 04 and 06
 Whole inches: 01* to 99
 Metric lengths and lengths over 99 inches consult factory.

10. Sheath Length "L" (fractional inch) _____
0 = No fraction, whole inches
 1 = 1/8 3 = 3/8 5 = 5/8 7 = 7/8
 2 = 1/4 4 = 1/2 6 = 3/4

11. Element _____
 100Ω Single 2-wire 3-wire 4-wire
 A B C

12. Temperature Coefficient _____
 DIN 0.00385
A = Class A
B = Class B

13-14. Lead Wire Length (foot) _____
02 and 04
 Whole feet: 01 to 99

15. Special Requirements _____
0 = None
 X = Special requirements, consult factory

RTDs and Thermistors

RTD Style RF Metal Transitions

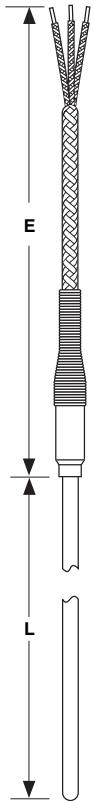

Features and Benefits

Stainless steel transitions

- Crimped to sheath and filled with 260°C (500°F) epoxy
- Optional brazing available

Coiled spring strain relief

- Protects lead wire against sharp bends in the transition area

Flexible mineral insulated construction

- Provides a bendable and highly durable sensor

Temperature rating

- -200 to 650°C (-328 to 1200°F)

High accuracy

- Dependable readings

Diameters available

- 0.125 to 0.250 inch O.D.

② Requires two- or three-wire only, single element only

Rapid Ship Sensors

Rapid Ship sensors come with 100Ω DIN 0.00385 curve, 316 stainless steel, 0.188 inch diameter, 24 AWG stranded Teflon® three-wire, four foot leads, temperature rating -200 to 650°C (-328 to 1200°F), standard split end lead termination and no mounting fittings. See page 166 to order additional connector hardware.

Class Accuracy	Sheath Length in. (mm)	Part Number 4 foot (102 mm) Leads
A	3 (76)	RFHB0TK030BA040
	6 (152)	RFHB0TK060BA040
	9 (229)	RFHB0TK090BA040
	12 (305)	RFHB0TK120BA040

Custom Ordering Information—Items in **Bolded Green Type** are preferred with shorter lead times.

1 2 3 4 5 6 7 8 9 10 11 12 13 14 15

R F

1-2. Style _____
 F = Metal transition with strain relief

3. Sheath O.D. (inch) _____
 G = 0.125
H = 0.188
J = 0.250

4. Lead Wire Construction _____
 Standard Overbraid Flex Armor
 Fiberglass Stranded **A** J R
 PFA or TFE Stranded **B** L T

5. Fittings _____
 If required, enter order code from pages 39 to 40.
If none, enter "0".

6. Lead Wire Termination _____
 A^② = Standard male plug
 B^② = Standard female plug
 C^② = Standard plug with mating connector
 J^② = Male miniature plug
 K^② = Female miniature jack
 L^② = Male/female mini set
T = Standard leads
 U = Leads with spade lugs

7. Sheath Construction _____
 316 SS Alloy 600
 Mineral Insulated **K** **L**

8-9. Sheath Length "L" (inch) _____
03, 06 and 12
 Whole inches: 03 to 99
 Metric lengths and lengths over 99 inches consult factory.

10. Sheath Length (fractional inch) _____
0 = No fraction, whole inches
 1 = ¼ 3 = ⅜ 5 = ½ 7 = ¾
 2 = ⅛ 4 = ¼ 6 = ⅜

11. Element _____
 2-wire 3-wire
 100Ω Single A **B**

12. Temperature Coefficient _____
 DIN 0.00385
A = Class A
B = Class B

13-14. Lead Wire Length "E" (foot) _____
02 and 04
 Whole feet: 01 to 99

15. Special Requirements _____
0 = None
 X = Special requirements, consult factory

RTDs and Thermistors

RTD Style RK

Emergency Use Cut-to-Length RTD

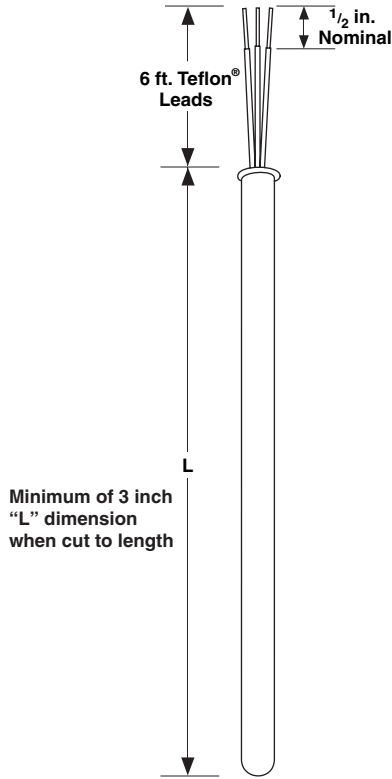

Rapid Ship Sensors

Rapid Ship sensors come with 100Ω DIN, 0.00385 curve, 316 stainless steel, 0.188 and 0.250 inch diameter, 24 AWG stranded Teflon® three-wire, temperature rating -50 to 260°C (-58 to 500°F), standard split end leads and no mounting fittings.

Class Accuracy	Diameter	"L" Dimension in. (mm)	Part Number (Contains Bag of Five Sensors)
A	0.188	12 (305)	RKH12A-05
	0.188	24 (610)	RKH24A-05
	0.250	12 (305)	RKJ12A-05
	0.250	24 (610)	RKJ24A-05

Adjustable C-Frame Tube Cutter	RK-Cutter
--------------------------------	-----------

NEW: Cut-to-length emergency RTD kit is a bag of five adjustable RTD sensors. Keep a bag of these items on your shelf for immediate, emergency replacement of RTDs to 24 inches in length.

Features and Benefits

Cut-to-length features

- Avoids need to stock several RTD lengths

Probes can be shortened

- To three inches minimum using a tubing cutter

High accuracy

- Dependable reading, three-wire, Class A DIN 0.00385 curve

Internally sealed

- Prevent moisture penetration

316 SS sheath

- -50 to 260°C (-58 to 500°F)

Teflon® is a registered trademark of E.I. du Pont de Nemours & Company.

RTDs and Thermistors

RTD Style RR

Connection Head/ Optional Transmitter

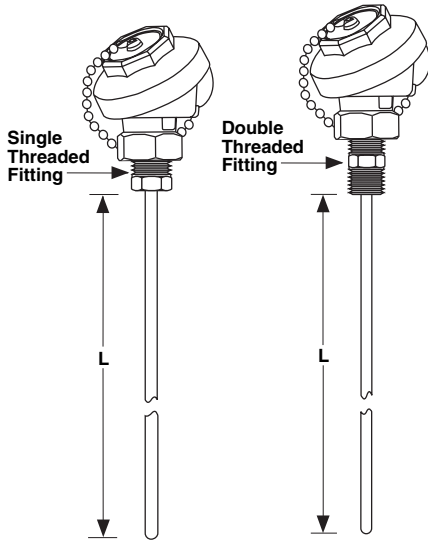

Features and Benefits

Connection heads

- Provide superior dust and moisture resistance

Weatherproof plastic heads

- Resist weak acids, organic solvents, alkalies, sunlight and dust

Standard bottom mounting

- Side mounting available upon request

Complete assembly available

- Head-mounted 4-20mA transmitter, two- or three-wire input and non-isolated

① Units with transmitter, buyer to specify range and degree C or F, as well as temperature span.



For further details on Watlow connection heads see the hardware section of this catalog, pages 156 to 157.

Rapid Ship Sensors

Rapid Ship sensors come with 100Ω DIN 0.00385 curve, 316 stainless steel, 0.250 inch diameter, cast aluminum industrial head, double threaded stainless steel fitting for head mount with 0.5 inch NPT process mount, three-wire configuration and a temperature rating of -50 to 260°C (-58 to 500°F).

Class Accuracy	Sheath Length in. (mm)	Part Number
A	3 (76)	RRJEFOA030BA000
	6 (152)	RRJEFOA060BA000
	18 (457)	RRJEFOA180BA000

Custom Ordering Information—Items in **Bolded Green Type** are preferred with shorter lead times.

	1	2	3	4	5	6	7	8	9	10	11	12	13	14	15
	R	R				0							0	0	
<p>3. Sheath O.D. (inch) G = 0.125 J = 0.250 H = 0.188</p> <p>4. Connection Head C = Polypropylene D = Cast iron E = Cast aluminum H = Explosion proof U^① = E head with 5750 transmitter V^① = C head with 5750 transmitter W^① = H head with 5750 transmitter</p> <p>5. Head Mounting Fittings O = Single threaded, 303 SS F = Double threaded, 303 SS ½" NPT *H = Spring loaded, double threaded, 316 SS ½" NPT</p> <p>6. Enter "0"</p> <p>7. Sheath Construction -50 to 260°C -200 to 650°C (-58 to 500°F) (-328 to 1200°F) 316 SS 316 SS</p> <p>Standard Industrial (0.125-0.250 inch O.D.) A —</p> <p>Mineral Insulated (0.125-0.250 inch O.D.) — K</p> <p>8-9. Sheath Length "L" (inches) 03, 06 and 18 Whole inches: 02 to 99 Metric lengths and lengths over 99 inches consult factory.</p> <p>10. Sheath Length "L" (fractional inch) 0 = No fraction, whole inches 1 = ¼ 2 = ½ 3 = ¾ 4 = 1 5 = 1 ¼ 6 = 1 ½ 7 = 1 ¾</p> <p>11. Element 2-wire 3-wire 4-wire 100Ω Single A B C</p> <p>12. Temperature Coefficient DIN 0.00385 A = Class A B = Class B</p> <p>13-14. Enter "00"</p> <p>15. Special Requirements 0 = None X = Special requirements, consult factory</p>															

* 0.250 inch diameter only.

RTDs and Thermistors



For a complete RTD assembly, add thermowell part number. See thermowell section, pages 144 to 146.

RTD Style RT

For Use with Thermowells

Type 1

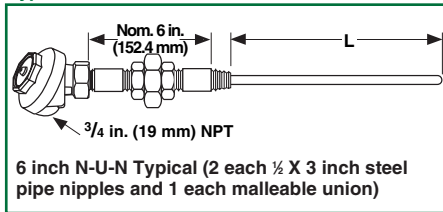

Type 2

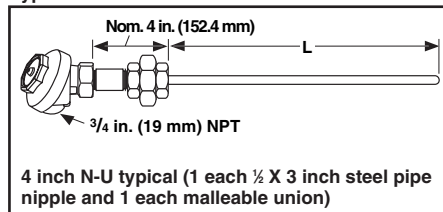

Type 3

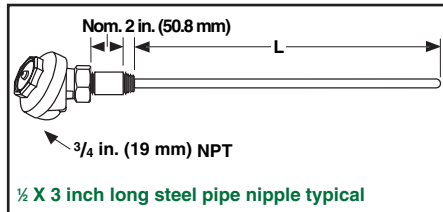

Type 4

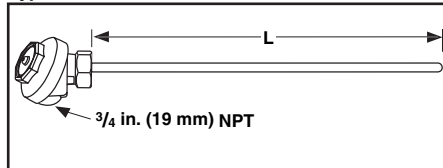

Features and Benefits

High quality thermowells and pipe wells

- Protect sensor

Mineral insulated construction

- Available in 0.125 to 0.250 inch O.D.

Available with spring-loading

- Ensures positive contact

Complete assembly available

- Head mounted 4-20mA transmitter, two- or three-wire input and non-isolated

Variety of connection head options

- Meet your application requirements

Custom Ordering Information—Items in **Bolded Green Type** are preferred with shorter lead times.

	1	2	3	4	5	6	7	8	9	10	11	12	13	14	15
	R	T				0									0
3. Sheath O.D. (inch)	_____														
G = 0.125	J = 0.250														
H = 0.188															
4. Connection Head	_____														
C = Polypropylene															
D = Cast iron															
E = Cast aluminum															
H = Explosion proof															
U ^① = E head with 5750 transmitter															
V ^① = C head with 5750 transmitter															
W ^① = H head with 5750 transmitter															
5. Cold End Configuration^②	_____														
Type 1	Type 2	Type 3	Type 4												
6. Enter "0"	_____														
7. Sheath Construction	_____														
	-50 to 260°C			-200 to 650°C											
	(-58 to 500°F)			(-328 to 1200°F)											
	316 SS			316 SS											
Standard Industrial	A			—											
Mineral Insulated	—			K											
8-9. Sheath Length "L" (see drawings at left)	_____														
When ordering a complete assembly with thermowell, specify "AR" as required. Otherwise, specify the "L" dimension in whole inches.															
10. Sheath Length "L" (fractional inch)	_____														
0 = No fraction, whole inches															
1 = 1/8	3 = 3/8	5 = 5/8	7 = 7/8												
2 = 1/4	4 = 1/2	6 = 3/4													
11. Element	_____														
	2-wire	3-wire	4-wire												
100Ω Single	A	B	C												
12. Temperature Coefficient	_____														
DIN 0.00385															
A = Class A															
B = Class B															
14. Spring-Loading	_____														
Y = Yes	N = No														
15. Special Requirements	_____														
0 = None															
X = Special requirements, consult factory															

① Units with transmitter, buyer to specify range and degree C or F, as well as temperature span.

② Other sizes, lengths and materials available. Consult factory.



For further details on Watlow connection heads see the hardware section of this catalog, pages 156 to 157.

RTDs and Thermistors

Style RT with Thermowell

Straight Well

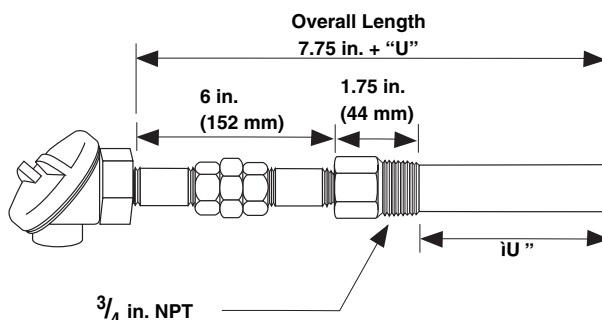

Rapid Ship Sensors

Rapid Ship sensors come with 316 SS straight well, nipple-union-nipple, 0.250 inch diameter spring loaded element, 100Ω DIN 0.00385 curve, Class A and three-wire RTD. Temperature rating -50 to 260°C (-58 to 500°F).

Calibration	"U" in. (mm)	Overall Length in. (mm)	Part Number
A	2.5 (64)	10.25 261	RTJE1SF024BA0Y0
	4.5 (114)	12.25 312	RTJE1SF044BA0Y0
	7.5 (191)	15.25 388	RTJE1SF074BA0Y0
	10.5 (267)	18.25 465	RTJE1SF104BA0Y0

Tapered Well

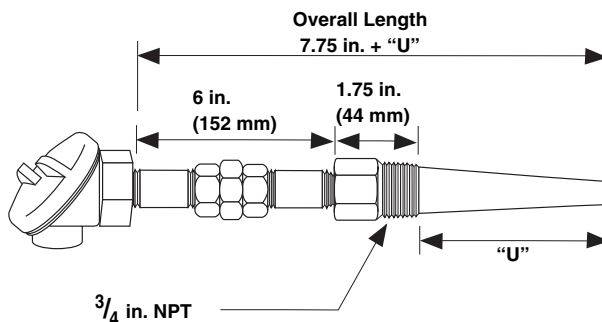

Rapid Ship Sensors

Rapid Ship sensors come with 316 SS tapered well, nipple-union-nipple, 0.250 inch diameter spring loaded element, 100Ω DIN 0.00385 curve, Class A and three-wire RTD. Temperature rating -50 to 260°C (-58 to 500°F).

Calibration	"U" in. (mm)	Overall Length in. (mm)	Part Number
A	2.5 (64)	10.25 261	RTJE1TF024BA0Y0
	4.5 (114)	12.25 312	RTJE1TF044BA0Y0
	7.5 (191)	15.25 388	RTJE1TF074BA0Y0
	10.5 (267)	18.25 465	RTJE1TF104BA0Y0

RTDs and Thermistors

Speciality RTDs and Thermistors

Construction Styles

10 = 6 in. Adjustable Spring Style
11 = 12 in. Adjustable Spring Style

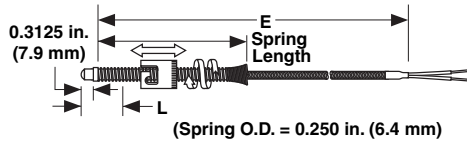

12 = Adjustable Armor Style

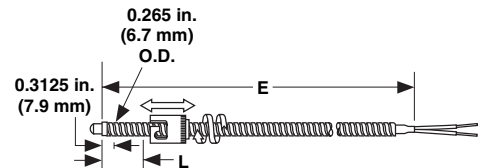

25 = Cartridge with Flange

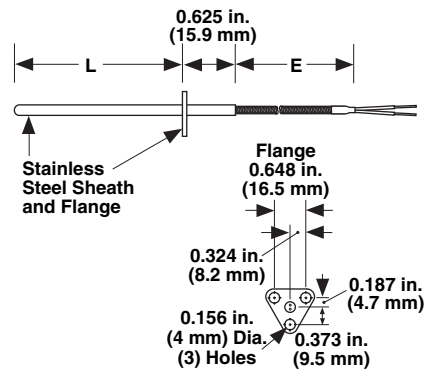

50 = Open Air

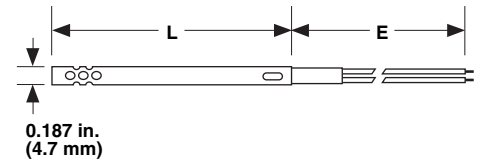

55 = Open Air with Flange

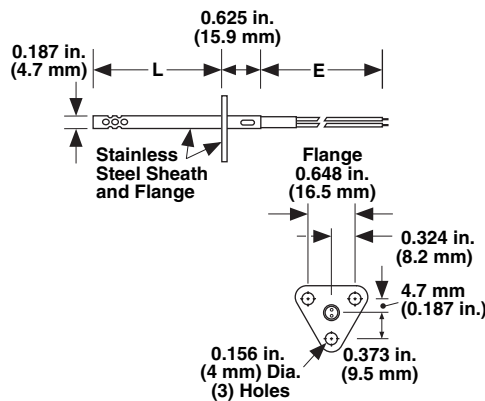

80 = Surface Mount

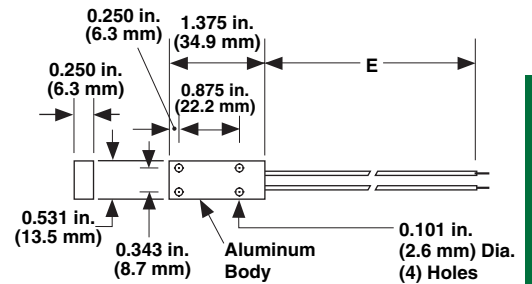

RTDs and Thermistors



See next page for
 Rapid Ship sensors and
 ordering instructions.

RTDs and Thermistors

Speciality RTDs and Thermistors

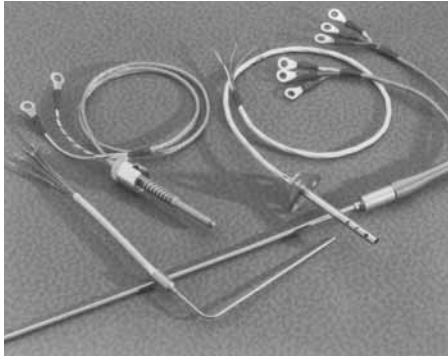

Specifications: RTD

- Two- or three-wire
- Resistance: 100Ω at 0°C
- Alpha curve: 0.00385Ω/Ω/°C
- Tolerance at 0°C: ±0.12% (±0.25°C)
- Range: -50 to 260°C (-58 to 500°F)

Specifications: Thermistor

- Metal oxide, sintered and encapsulated
- Negative temperature coefficient
- Non-linear temperature/resistance curve
- Resistance at 25°C (77°F) and ranges:

Epoxy Bead Tolerance ±1%Ω +0.3°C (37°F)		
#11	1000Ω	-60 to 150°C (-76 to 302°F)
#12	3000Ω	-60 to 150°C (-76 to 302°F)

Glass Bead Tolerance ±15%Ω +0.3°C (37°F)		
#16	100,000Ω	-60 to 260°C (-76 to 500°F)

*Other thermistors available on request. Consult factory. See Style TB thermistor on page 109.

Rapid Ship Sensors

Rapid Ship sensors come with 100Ω DIN 0.00385 curve RTD sensor, 24 AWG stranded three-wire leads, temperature rating -50 to 260°C (-58 to 500°F), standard split end lead termination and no mounting fittings.

	Part Number	
	4 Foot (102 mm) Leads	6 Foot (152 mm) Leads
Construction 10 with Fiberglass and SS overbraid leads	S10DDN4C048A	S10DDN4C072A
Construction 80 with Teflon® leads	S80ADT2A048A	S80ADT2A072A

Custom Ordering Information—Items in **Bolded Green Type** are preferred with shorter lead times.

1 **S** **2** **3** **4** **5** **6** **7** **8** **9** **10** **11** **12**

2-3. Construction —————

10 = 6 inch adjustable spring style
 11 = 12 inch adjustable spring style
 12 = Adjustable armor style
 25 = Cartridge with flange
 50 = Open air
 55 = Open air with flange
80 = Surface mount

4. Diameter (inch) —————

D = 0.188
 A = Not applicable: surface mount

*** 5. Element Type** —————

C = RTD 2-wire No. 3850 N = Thermistor No. 12
D = RTD 3-wire No. 3850 P = Thermistor No. 16
 M = Thermistor No. 11

6-7. Lead Type —————

L4 = Fiberglass and SS armor
 M4 = Fiberglass
 N4 = Fiberglass and SS overbraid
T2 = PFA or TFE

8. Sheath Length "L" (inches) —————

A = Not applicable
 C = 1.5 (required for VAT construction: No. 10, 11, 12)
D = 2.0 L = 5.5 T = 9.0
 E = 2.5 **M = 6.0** U = 9.5
 F = 3.0 N = 6.5 W = 10.0
 G = 3.5 P = 7.0 Y = 11.0
H = 4.0 Q = 7.5 Z = 12.0
 J = 4.5 R = 8.0
 K = 5.0 S = 8.5

9-11. Lead Wire Length "E" (foot) —————

012 = 1 084 = 7
024 = 2 096 = 8
 036 = 3 108 = 9
048 = 4 120 = 10
 060 = 5 180 = 15
 072 = 6

12. Terminations —————

A = 1.5 inch stripped split leads, no terminals
 B = No. 8 spade terminals
 H = 0.25 inch female quick connect terminals

RTDs and Thermistors

Speciality RTDs and Thermistors

Style TB Standard Industrial Thermistor with Insulated Leads

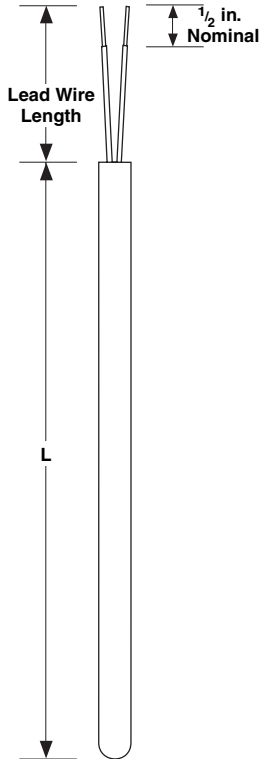

Features and Benefits

Rigid 316 stainless steel sheath

- Ideal for industrial applications

Cold end epoxy seal

- Rated to 260°C (500°F)

Internal heat transfer paste

- Quick time response

Custom Ordering Information—Items in **Bolded Green Type** are preferred with shorter lead times.

	1	2	3	4	5	6	7	8	9	10	11	12	13	14	15
	T	B		B								O			
3. Sheath O.D. (inch)	_____														
H = 0.188															
J = 0.250															
4. Lead Wire Construction	_____														
Standard															
PFA or TFE Stranded	B														
5. Fittings	_____														
If required, enter order code from pages 39 to 40.															
If none, enter "0".															
6. Lead Wire Termination	_____														
T = Standard leads															
U = Leads with spade lugs															
7. Temperature Rating and Accuracy	_____														
A ^① = -60 to 150°C (-75 to 302°F) ±1% (±.3°C) Accuracy @ 25°C															
B ^② = -60 to 260°C (-75 to 500°F) ±15% (±.3°C) Accuracy @ 25°C															
8-9. Sheath Length "L" (inches)	_____														
02, 04 and 06															
Whole inches: 02 to 24															
10. Sheath Length "L" (fractional inch)	_____														
0 = No fraction, whole inches															
1 = 1/8 5 = 5/8															
2 = 1/4 6 = 3/4															
3 = 3/8 7 = 7/8															
4 = 1/2															
11. Element/Resistance at 25°C (77°F)	_____														
E = 1,000Ω															
G = 3,000Ω															
T = 100,000Ω															
12. Sheath	_____														
O = Standard sheath															
13-14. Lead Wire Length "E" (foot)	_____														
02 and 04															
Whole feet: 01 to 15															
15. Special Requirements	_____														
0 = None															
X = Special requirements, consult factory															

① Only available with 1,000Ω or 3,000Ω.

② Only available with 100,000Ω.

RTDs and Thermistors

ENVIROSEAL™ HD Sensor

Watlow's ENVIROSEAL™-HD temperature sensor keeps out moisture, oil and contaminants in all of your heavy-duty applications including those outside applications exposed to harsh weather, oils and other extreme moisture environments. The ENVIROSEAL-HD sensor is also designed to provide accurate, dependable measurements in high-vibration environments.

Features and Benefits

Submersible and 1200psi pressure wash rated seal (not including connector area)

- Protects the sensor from washdown or other extreme moisture environments

Oil Resistant Materials

- Sensors maintain a long life even when exposed to oil, gasoline, or diesel fuel

Vibration resistant design, 25 lb pull out force rating

- Tough, rugged design to hold up to the roughest applications

-40 to 200°C (-40 to 392°F) sensor temperature rating

- Offers superior application flexibility

Time response of two seconds

- Fast response will measure 63.2 percent (first order) of the temperature change in two seconds or less

250psi threaded fitting pressure rating

- Suitable for most rugged applications

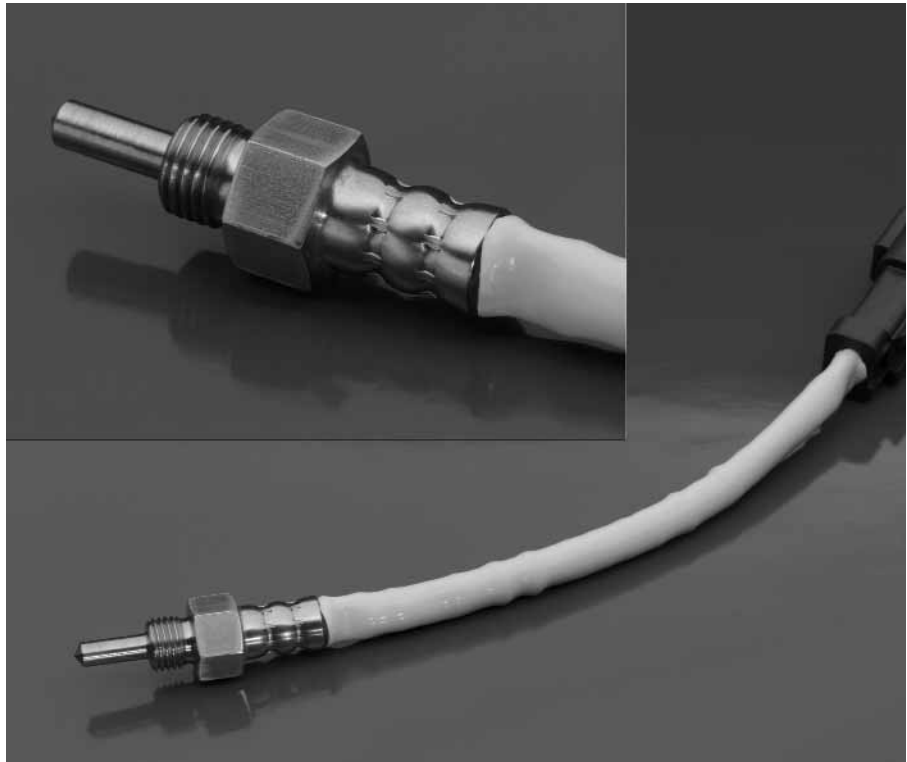

Applications

- Engine coolant or oil
- Refrigeration or condensation units
- Industrial equipment
- Heat exchangers
- Gear boxes
- Hydraulic fluid
- Marine

RTDs and Thermistors

ENVIROSEAL™ HD Sensor

Ordering Information—To order, complete the part number on the right with the information below:

1 2 3 4 5 6 7 8 9 10
H D

3. Sensor Type

- A = 100Ω DIN 0.00385 RTD Class A element, 2-wire
- B = 100Ω DIN 0.00385 RTD Class B element, 2-wire
- C = 1000Ω DIN 0.00385 RTD Class A element, 2-wire
- D = 1000Ω DIN 0.00385 RTD Class B element, 2-wire
- K = Ungrounded standard limits Type K thermocouple

4-5. Sheath Length “S”

- 07 = 0.75 in. (19.05 mm)
- 15 = 1.50 in. (38.1 mm)
- 30 = 3.00 in. (76.2 mm)

6. Threaded Fitting

- 4 = 0.25 in. (6.35 mm) NPT male threads
 "F" = 1.4 in. (35.56 mm)
- 8 = 0.125 in. (3.18 mm) NPT male threads
 "F" = 1.2 in. (30.48 mm)

7. Fitting Material

- B = Brass
- S = 316 stainless steel

8-9. Lead Length “L” (whole inches)

(18 gauge stranded conductor lead wire)

- 06 = 6 in. (152.4 mm)
- 12 = 12 in. (304.8 mm)
- 24 = 24 in. (609.6 mm)

10. Lead Wire Terminations

- T = Standard 0.25 in. (6.35 mm) stripped ends
- 2 = 2-pin receptacle Deutsch connector 125°C (257°F)
- 4 = 2-pin receptacle Deutsch connector 125°C (257°F) with mating connector

