

DATE: _____ CUSTOMER: _____
 PHONE: _____ CONTACT: _____
 FAX: _____ EMAIL: _____

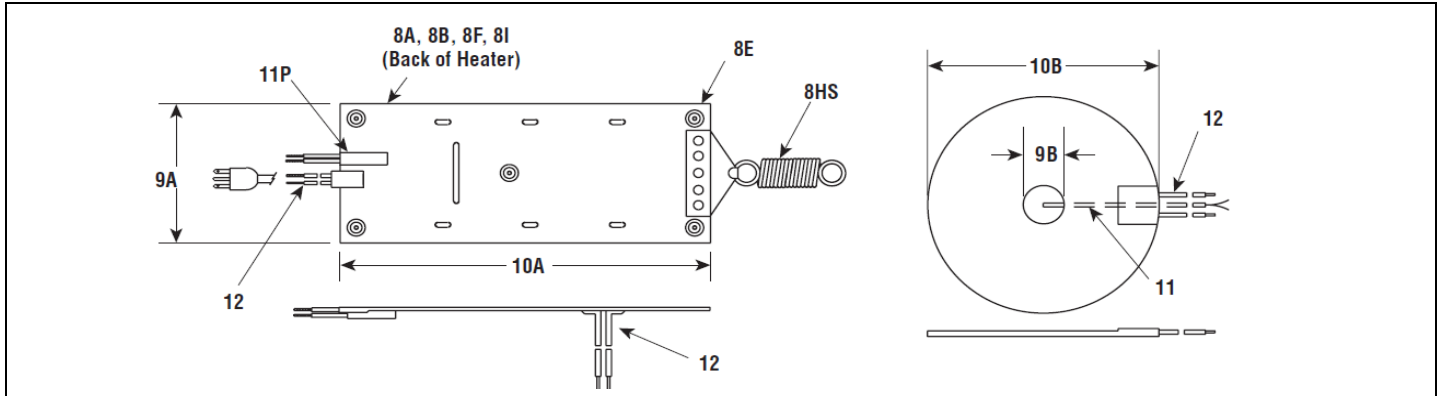











Note: Drawing is for illustration purposes only.

Operating Conditions

APPLICATION (Describe in detail): _____

MATERIAL:	<input type="checkbox"/> GAS	<input type="checkbox"/> LIQUID	<input type="checkbox"/> SOLID	MAX WORK TEMPERATURE:	° <input type="checkbox"/> F <input type="checkbox"/> C
ENVIRONMENT:	<input type="checkbox"/> INDOOR	<input type="checkbox"/> OUTDOOR		MAX WATT DENSITY ALLOWED:	
HAZARD CLASS:	Division:	Group:		AMBIENT TEMPERATURE:	° <input type="checkbox"/> F <input type="checkbox"/> C

Heater Specifications:

RATING:	VOLTS:	WATTS:	<input type="checkbox"/> 3 PHASE	<input type="checkbox"/> 3 PH WYE	<input type="checkbox"/> 3 PH DELTA							
DIMENSIONS:	DIAMETER:	WIDTH:	LENGTH:	VESSEL DIA.:	AREA:							
SHAPE:	<input type="checkbox"/> RECTANGULAR	<input type="checkbox"/> SQUARE	<input type="checkbox"/> ROUND	<input type="checkbox"/> OTHER:								
INSULATION:	<input type="checkbox"/> SILICONE RUBBER	<input type="checkbox"/> KAPTON	CONSTRUCTION:	<input type="checkbox"/> WIRE	<input type="checkbox"/> FOIL <input type="checkbox"/> THICK FILM							
LEADS:	LENGTH:	TYPE:	<input type="checkbox"/> TEFLON	<input type="checkbox"/> POWER CORD	<input type="checkbox"/> GRD. CORD & PLUG	<input type="checkbox"/> CORD & PLUG						
	LOCATION:	<input type="checkbox"/> A	<input type="checkbox"/> B	<input type="checkbox"/> C	<input type="checkbox"/> D	<input type="checkbox"/> E	<input type="checkbox"/> F	<input type="checkbox"/> G	<input type="checkbox"/> H	<input type="checkbox"/> I	<input type="checkbox"/> J	<input type="checkbox"/> K
												
THERMOSTAT:	<input type="checkbox"/> PRESET	Type:	Temp Setting (Opens):	Adjust Range:								
		LOCATION (Specify):										
THERMOCOUPLE:	<input type="checkbox"/> TYPE J	<input type="checkbox"/> TYPE K	<input type="checkbox"/> RTD	<input type="checkbox"/> THERMISTOR	SENSOR LEAD LENGTH:							
MOUNTING:	<input type="checkbox"/> PSA	<input type="checkbox"/> FIELD APPLIED ADHESIVE	<input type="checkbox"/> BOOTS, HOOKS & SPGS	Qty:								
	<input type="checkbox"/> CLAMPS	<input type="checkbox"/> SILICONE CONTACT CEMENT	<input type="checkbox"/> EYELETS & GROMMETS	Qty:								
	<input type="checkbox"/> CORD:	Length:	<input type="checkbox"/> STRAPS with VELCRO	Qty:	Length:							
	<input type="checkbox"/> VULCANIZE (Describe)		<input type="checkbox"/> STRAPS with D-RINGS	Qty:	Length:							
	<input type="checkbox"/> SPONGE INSULATION:	Thickness:	Describe:									
APPROVALS:	<input type="checkbox"/> NONE	<input type="checkbox"/> UL COMP CERTIFIED	<input type="checkbox"/> CSA CERTIFIED	<input type="checkbox"/> OTHER:								